

jWIN[®]

**STEREO HI-FI SYSTEM
with 4 CD CHANGER / MP3
and AM/FM PLL SYNTHESIZED TUNER
MODEL JX-CD8700**

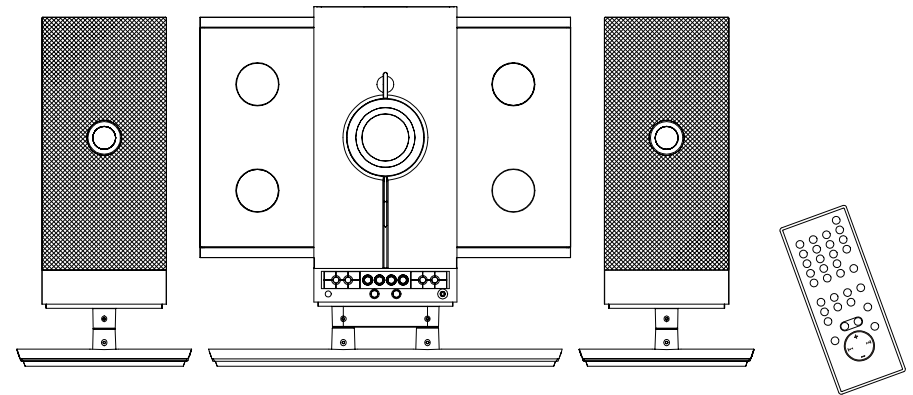

OWNER'S MANUAL



Visit our Web Site: <http://www.jwin.com>

JXCD8700V10M12EN05062005

IMPORTANT SAFETY INSTRUCTIONS

WARNING:

TO PREVENT FIRE OR SHOCK HAZARD, DO NOT USE THIS PLUG WITH AN EXTENSION CORD, RECEPTACLE OR OTHER OUTLET UNLESS THE BLADES CAN BE FULLY INSERTED TO PREVENT BLADE EXPOSURE. TO PREVENT FIRE OR SHOCK HAZARD. DO NOT EXPOSE THIS APPLIANCE TO RAIN OR MOISTURE.

 <p>This lightning flash with arrowhead symbol, within an equilateral triangle, is intended to alert the user to the presence of uninsulated "dangerous voltage" within the product's enclosure that may be of sufficient magnitude to constitute a risk of electric shock persons.</p>	<p>CAUTION RISK OF ELECTRIC SHOCK DO NOT OPEN</p> <p>Warning: to reduce the risk of electric shock, do not remove cover (or back) no user-serviceable parts inside. Refer servicing to qualified service personnel.</p>	 <p>The exclamation point within an equilateral triangle is intended to alert the user to the presence of important operating and maintenance (servicing) instructions in the literature accompanying the appliance.</p>
--	--	---

1. Read these instructions.
2. Keep these instructions.
3. Heed all warnings.
4. Follow all instructions.
5. Do not use this apparatus near water.
6. Clean only with dry cloth.
7. Do not block any ventilation openings. Install in accordance with the manufacturer's instructions.
8. Do not install near any heat sources such as radiators, heat registers, stoves, or other apparatus (including amplifiers) that produce heat.
9. Do not defeat the safety purpose of the polarized or grounding type plug. A polarized plug has two blades with one wider than the other. A grounding type plug has two blades and a third grounding prong. The wide blade or the third prong are provided for your safety. If the provided plug does not fit into your outlet, consult an electrician for replacement of the obsolete outlet.
10. Protect the power cord from being walked on or pinched particularly at the plugs, convenience receptacles, and at the point where they exit from the apparatus.
11. Only use attachments/accessories specified by the manufacturer.
12. Unplug the apparatus during lightning storms or when unused for long periods of time.
13. Refer all servicing to qualified personnel. Servicing is required when the apparatus has been damaged in any way, such as power supply cord or plug is damaged, liquid has been spilled or objects have fallen into the apparatus, the apparatus has been exposed to rain or moisture, does not operate normally, or has been dropped.
14. This appliance shall not be exposed to dripping or splashing water and objects filled with liquids such as vases must not be placed on apparatus.

CAUTION: TO PREVENT ELECTRICAL SHOCK, MATCH WIDE BLADE PLUG TO WIDE SLOT AND FULLY INSERT.

PRECAUTIONS

CAUTION:

- To avoid electric shock, this unit must not be exposed to dripping or splashing water
- Minimum distances around the apparatus for sufficient ventilation;
- The ventilation should not be impeded by covering the ventilation openings with items, such as newspapers, table-cloths curtains, etc.
- No naked flame sources, such as lighted candles, should be placed on the apparatus;
- Before scrapping the appliance, remove the batteries and place them in the appropriate battery collection container.

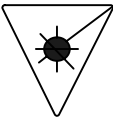
<p>CAUTION CLASS 1 LASER PRODUCT</p> <p>Use of Controls or adjustments or performance of procedures other than those specified herein may result in hazardous radiation exposure.</p> <div data-bbox="1310 598 1568 710" style="border: 2px solid black; padding: 5px; text-align: center;"> <p>CLASS 1 LASER PRODUCT LUOKAN 1 LASERLAITE KLASS 1 LASERAPPARAT</p> </div> <p>CAUTION CLEANING: Always disconnect unit from power supply before attempting to clean it. Use soft cloth moistened with soapy water, wipe gently. Do not use solvents or abrasive materials.</p>	<p>LASER SAFETY</p> <p>This unit employs a laser. Only qualified service personnel should attempt repair.</p> <div data-bbox="1680 558 1792 678" style="text-align: center;">  </div> <p>DANGER: INVISIBLE LASER RADIATION WHEN OPEN AND INTERLOCK FAILED OR DEFEATED. AVOID DIRECT EXPOSURE TO BEAM. CAUTION: HAZARDOUS LASER RADIATION WHEN OPEN AND INTERLOCK DEFEATED.</p>
--	--

INSTALLATION

MAIN UNIT ASSEMBLY AND DISASSEMBLY

CAUTION - This product may use only with JWIN model JX-CD8500 stand. Use with other stands may result in instability causing possible injury.

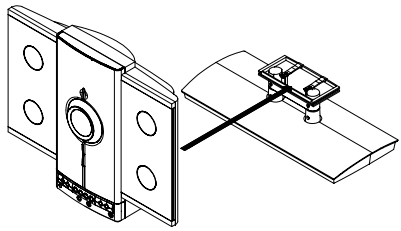

STEP 1

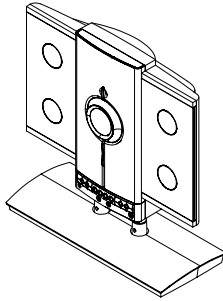

STEP 2

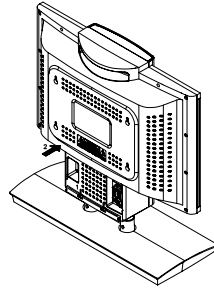

STEP 3

SPEAKER ASSEMBLY AND DISASSEMBLY

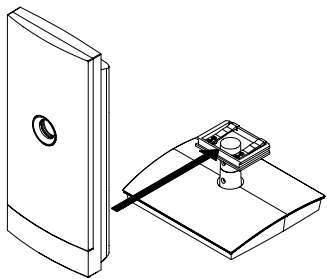

STEP 1

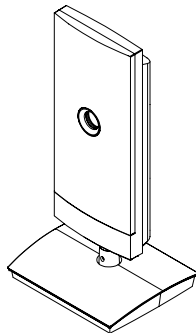

STEP 2

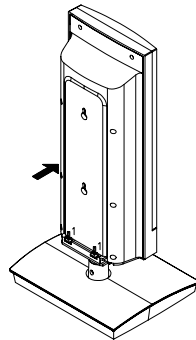

STEP 3

INSTALLATION (Wall Mounting)

- Secure the center unit and speakers on the wall (as show below) using 8 dowels and 8 screws (supplied).

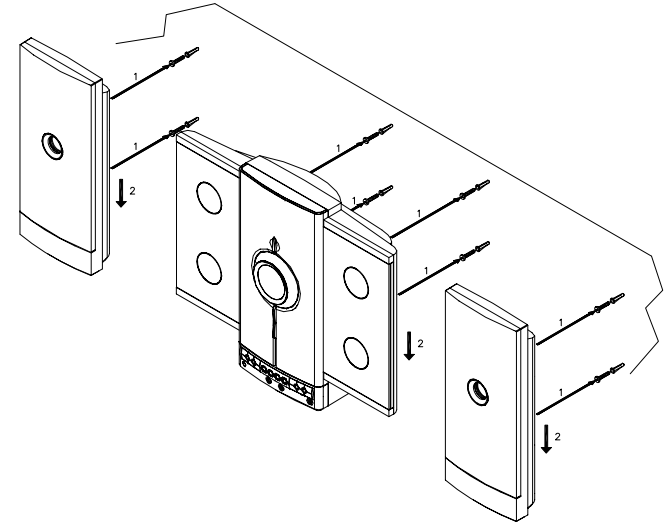

CONTROLS

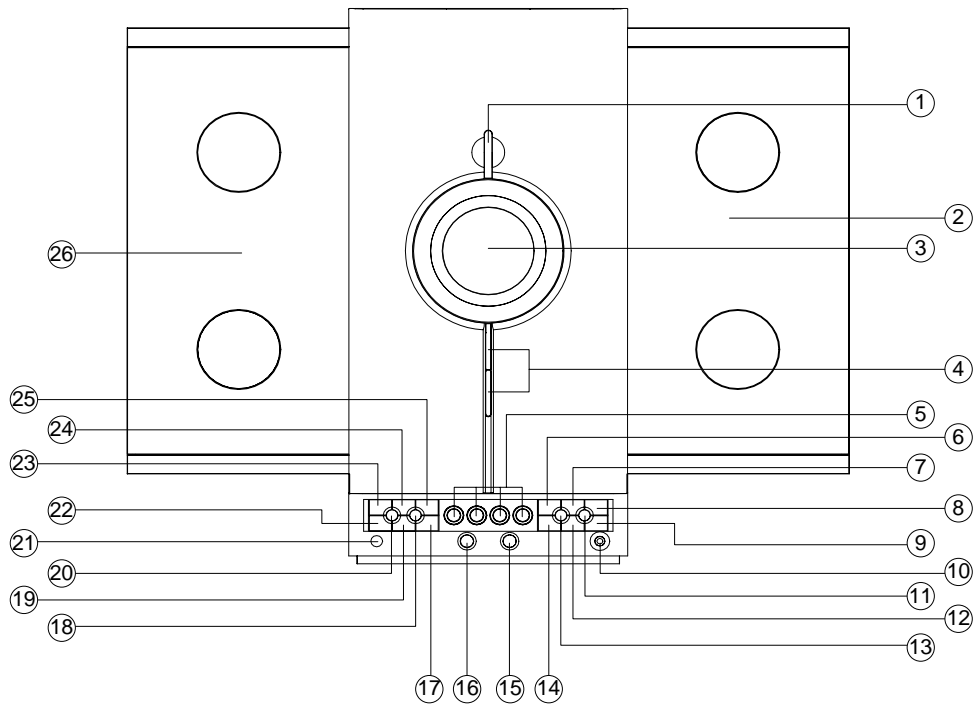

Front view

1. **POWER Button**
Used to turn the system on and off
2. **RIGHT CD DOOR**
3. **DISPLAY**
4. **VOLUME UP/DOWN Button**
Used to select the desired volume
5. **CD SELECTION 1-4 Button**
Selects a CD to play from one of the 4 players
6. **EQ Button**
Selects among "FLAT, POP, ROCK, JAZZ and DISCO" as the tonal qualities desired for any selection
7. **TUNER/BAND Button**
Activates the TUNER and selects the AM, FM, or FM/Stereo reception bands
8. **MUTE Button**
Temporarily switches off the audio if desired
9. **MEM./CLK ADJ. Button**
Supplies memory functions for tuner station presets, clock setting, and CD programming
10. **HEADPHONES Jack**
Stereo headphone socket: accepts 3.5mm plug
11. **■ STOP/FM ST. Button**
Interrupts the CD playback / clearing the CD programme, provides stereo-mono switching for FM stations
12. **REPEAT/PRESET Button**
Repeat function for CD mode / retrieve preset radio stations
13. **▶|| PLAY/PAUSE Button**
Initiates CD operation and starts CD playback / pauses CD playback
14. **MP3 MODE Button**
Selects TITLE or ALBUM(folder) in MP3 mode
15. **OPEN/CLOSE R Button**
Opens and closes the right CD changer door
16. **OPEN/CLOSE L Button**
Opens and closes the left CD changer door
17. **DISPLAY MODE Button**
Switching to time display (TIMER ON / OFF)
18. **▶▶ TUNING + SKIP/SEARCH Button**
CD forward title selection / CD forward search operation / Manual tuning of stations, station search operation

19. **FOLDER DOWN Button**
Activates the MP3 folders (in descending order)
20. **◀◀ TUNING - SKIP/SEARCH Button**
CD backward title selection / CD backward search operation / Manual tuning of stations, station search operation
21. **REMOTE SENSOR**
Receives infrared signals from the remote control
22. **TIMER Button**
Activates the timer
23. **SNOOZE Button**
Turns off the unit for 9 minutes, after which the unit will then resume its previous function
24. **FOLDER UP Button**
Activates the MP3 folder (in ascending order)
25. **SLEEP Button**
Set the automatic switch-off time
26. **LEFT CD DOOR**

CONNECTIONS

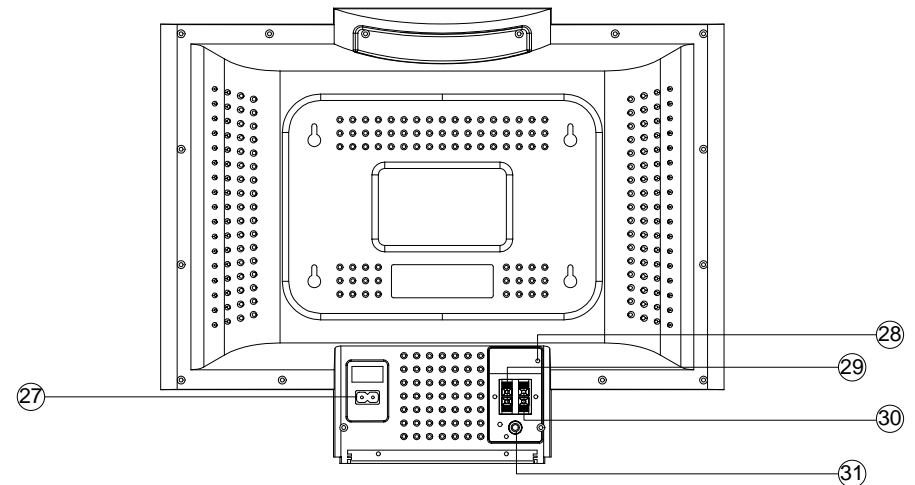

Rear view

27. **AC**
Plug the AC power cord into this socket before plugging it into the wall outlet
Note:
When the system is connected to AC power, parts of the unit may be in operation due to its stand-by function. In order to switch the system off completely, remove the AC power cord from the AC outlet.
28. **FM ANT.**
FM antenna "pigtail" wire
Note: Do not connect to an external antenna
29. **SPEAKERS R**
Terminals for the right channel speaker
30. **SPEAKERS L**
Terminals for the left channel speaker
31. **SUBWOOFER Output Jack**
Optionally, connect an external subwoofer speaker (not included)

Antenna connection

You can achieve acceptable reception if you use the supplied FM "pigtail" antenna. If so, the antenna should be elongated and not coiled or bunched up. If it hangs freely, it can be quite effective.

Speaker connection

Insert LEFT spkr's striped wire into LEFT channel's SPKR block (30) by pressing the RED lever and inserting the striped wire into the open hole. Do the same with the LEFT speaker's non-striped wire and the BLACK lever. Repeat for the RIGHT channel SPKR block (29) and the RIGHT speaker's wire.

AC power connection

Connect the power cable (included in the accessories) **first** to the power socket (27) at the unit and then insert the power plug into the wall outlet. When you disconnect the plug from a socket, do not pull the cable, always pull the plug.

Note: As soon as the unit has been connected to AC power, parts of the unit are in operation, due to the standby function. To switch off the unit completely, remove the plug from the AC outlet.

Once the unit is plugged in, its time display (3) starts flashing, refer to "Setting the digital clock" on P.11.

REMOTE CONTROL

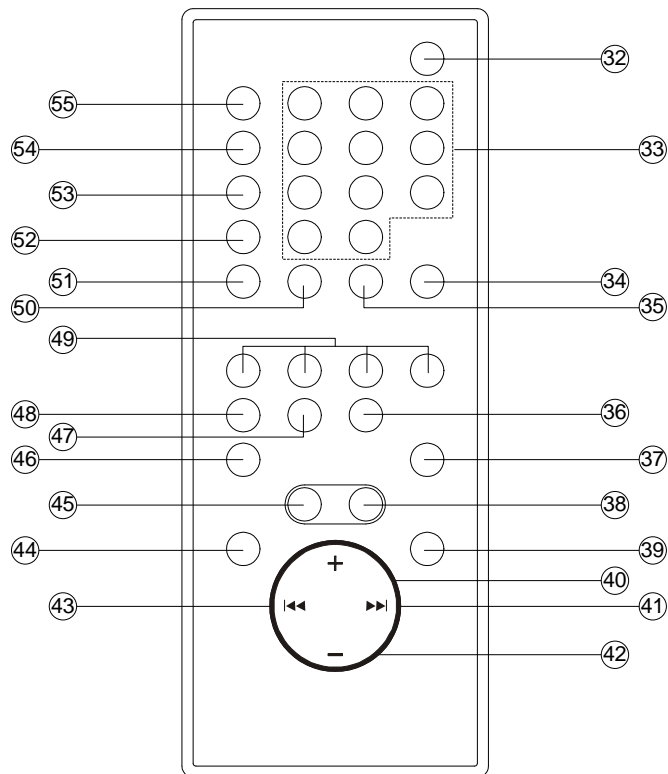

32. POWER Button

Used to turn the system on and off

33. 0 - 9, +10 NUMERIC Button

Recalls TUNER preset stations / Recalls CD tracks

34. INTRO Button

Plays the first 10 seconds of each CD track

35. RANDOM Button

Randomizes the playback of CD tracks

36. PRESET Button

Retrieves preset AM and FM radio stations

37. SNOOZE Button

Turns off the unit for 9 minutes, after which the unit will then resume its previous function

38. PLAY/PAUSE Button

Initiates CD operation and starts CD playback / pauses CD playback

39. EQ Button

Selects among "FLAT, POP, ROCK, JAZZ and DISCO" as the tonal qualities desired for any selection

40. VOLUME + Button

Adjusts to the desired volume (louder)

41. ►► TUNING + SKIP/SEARCH Button

CD forward title selection / CD forward search operation / Manual tuning of stations, station search operation

42. VOLUME - Button

Adjusts to the desired volume (down)

43. ◀◀ TUNING - SKIP/SEARCH Button

CD backward title selection / CD backward search operation / Manual tuning of stations, station search operation

44. FOLDER DOWN Button

Activates the MP3 folders (in descending order)

45. STOP Button

Stops CD playback / Clears the CD program memory

46. FOLDER UP/STEREO/MONO Button

Activates the MP3 folder (in ascending order) / Stereo/mono switching for FM stations

47. REPEAT Button

Selects among CD playback repeat functions

48. DISPLAY MODE Button

Switching to time display (TIMER ON / OFF)

49. DISC 1 - 4 Button

Selects a CD to play from one of the 4 players

50. MEMORY/CLK ADJ. Button

Supplies memory functions for tuner station presets, clock setting, and CD programming

51. MP3 MODE Button

Selects TITLE or ALBUM(folder) in MP3 mode

52. SLEEP Button

Set the automatic switch-off time

53. TUNER/BAND Button

Activates the TUNER and selects the AM, FM, or FM/Stereo reception bands

54. TIMER Button

Activates the timer

55. MUTE Button

Temporarily silences the audio

REMOTE CONTROL

Battery Installation

1. Remove the battery tray by pressing point (1a) inside, then sliding point (1b) area at the same time.
2. Pull out the battery tray.
3. Install or replace the button-type battery "CR2032" (supplied).
4. Close the battery tray.

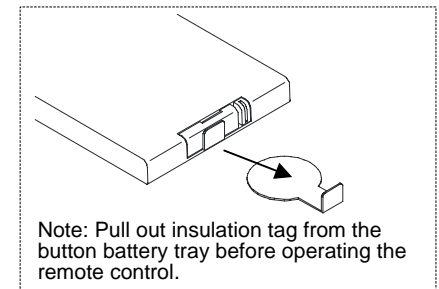
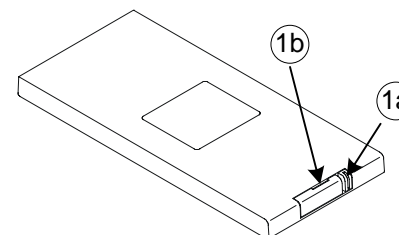

Warning: Danger of explosion if battery is incorrectly replaced. Replace only with the same or equivalent type.

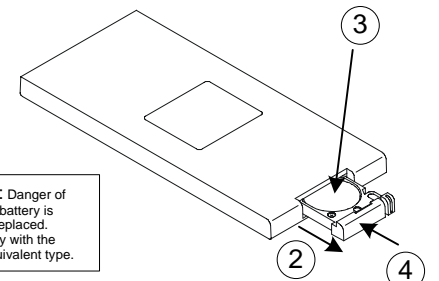

AMPLIFIER AND RADIO FACILITY

Switching the unit ON

Press the "POWER" button (1)/(32) to turn on the system.

Operating mode selection

The different operating modes can be directly selected using the buttons "PLAY / PAUSE ► II" (13)/(38) for CD operation and "TUNER / BAND" (7)/(53) for radio reception (3).

PLAY / PAUSE ► II : playback from the built-in compact disc player

TUNER / BAND: radio, selection of the frequency bands

Adjusting the volume

To adjust the volume, press the "VOLUME UP/DOWN" button (4)/(40)/(42).



To switch off the sound, press "MUTE" button (8)/(55). This function is indicated by the word, MUTE in the display (3).



By pressing this button or "VOLUME UP/DOWN" button (4)/(40)/(42) again, the sound is switched back on.

Caution! Too high a volume, especially with headphones, may damage your hearing.

Headphones socket

The headphones "PHONES" jack (10) is for headphones with a 30 to 600 ohm impedance, and equipped with a 3.5mm jack. Use an adapter (sold in electronic outlets) if your headphone has a different plug. The speakers are automatically switched off when the headphones are being used.

CAUTION:

Listening at high power for a long periods could damage users' ears.

AM/FM radio operation

Switch the unit on by pressing the "POWER" button (1)/(32). Switch to the Tuner operating mode by pressing the button "TUNER / BAND" (7)/(53).



Manual station selection

Press button "TUNER / BAND" (7)/(53) repeatedly until the desired frequency band appears. Press the buttons "TUNING - or TUNING +" (20)/(43) or (18)/(41) to tune to the desired radio stations and have them indicated in display (3).

Briefly tapping the button "TUNING - or TUNING +" step by step alters the reception frequency upward or downward.

Station search operation

Holding down one of the two buttons "TUNING - or TUNING +" (20)/(43) or (18)/(41) for approx. 1 second starts the search operation and determines the direction of the search. The search operation simply finds stations with strong signals. Stations with weak reception can only be tuned in manually. Hold the "TUNING - or TUNING +" button to start the station search again. During the search operation, the tuner is muted.

Stereo / Mono

Repeatedly pressing the button "STEREO / MONO" (46) switches between stereo and mono reception. The stereo reception of a station in the FM band is indicated on the display (3)



In the case of stereo stations with a bad (noisy) reception, we recommend switching tuner to mono reception. Press the "STEREO / MONO" push-button. In the display (3), the message STEREO disappears in mono mode.

About the tuner's preset station memories

Each time the "MEM./CLK ADJ." button (9)/(50) is pressed, the memory positions are called up one after another in ascending number order.

The memory positions are selected directly using the numerical keys "1 - 0 / +10" (33) on the remote control.

Program sites 1 - 9; press the corresponding key "1- 9".

Program sites 10 - 19; Press button "+10" and then the appropriate button "0 - 9".

Program site 20; Press button "+10" twice and then the button "0".

Programming AM and FM Stations in Memory

The program memory allows you store 30 stations in FM and AM range. Program place selection is described in the previous operating section.

1. In TUNER mode, select to FM or AM reception.
2. Seek out the station required by "Manual station selection" or "Station search operation".
3. Press the "MEM./CLK ADJ." (9)/(50) and then



press the "REPEAT/PRESET" (12, front panel) or "PRESET" (36, remote) until the desired memory preset appears.

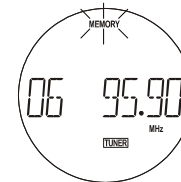

4. Press the "MEM./CLK ADJ." button again to store the station along with its preset. Repeat as required.

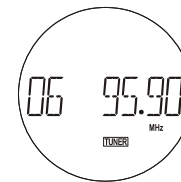

Note: You can also directly select the desired program preset by pressing numeric buttons "1-0 / +10" (33) on the remote control. Store any remaining stations by repeating the process.

Changing a program position

If a memory position needs to be replaced by a station other than the current one, the new station can be programmed as described above, and will replace the original station.

DIGITAL CLOCK AND TIMER

Setting the digital clock

When you first plug in the unit, the display shows:

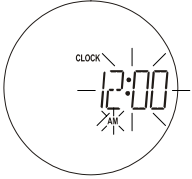

To set the clock to the current time proceed as follows:

1. Press **MEM./CLK ADJ.** The hour flashes.
2. Enter the hour by pressing the buttons **▶▶ TUNING + SKIP/SEARCH** or **◀◀ TUNING - SKIP/SEARCH**.
3. Confirm the entry by pressing **MEM./CLK ADJ.** The minutes will flash.
4. Enter the minutes by pressing the buttons **▶▶ TUNING + SKIP/SEARCH** or **◀◀ TUNING - SKIP/SEARCH** and confirm with **MEM./CLK ADJ.**



To switch to the clock display while in tuner and CD modes, press **DISPLAY MODE**. The time is displayed for approximately 10 seconds. The time is also displayed when the unit is turned off.

Setting the timer

You can set automatic switch-on and switch-off times with the built-in timer. Before you do this, be sure the clock is set correctly.

1. With the unit on, press **DISPLAY MODE** (17)/(48), as required, until **TIMER ON** appears in the display.
2. Press **MEM./CLK ADJ.** (50). The hour flashes. Use the **▶▶ TUNING + SKIP/SEARCH** or **◀◀ TUNING - SKIP/SEARCH** to set the hour of the desired switch-on time.



3. To set the minutes, press the **MEM./CLK ADJ.** again and use **▶▶ TUNING + SKIP/SEARCH** and **◀◀ TUNING - SKIP/SEARCH** to adjust. Confirm by pressing **MEM./CLK ADJ.**
4. Press **DISPLAY MODE** to proceed to setting the switch-off time.

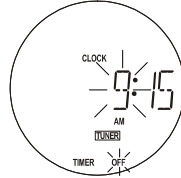

5. Set the switch-off time using the same procedure as switch-on time setting.
6. Press **DISPLAY MODE**, as required to check the current time, Timer On, and Timer Off.
7. Press **TIMER** (22)/(54) to activate the timer.

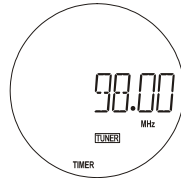

When the unit is on standby it will automatically switch on for the programmed length of time. The unit automatically selects the operating mode (CD or TUNER) it was in when last switched off. Make sure the tuner is tuned to a radio station, or for CD operation, a CD must be inserted.

Snooze function: When the unit is switched on by means of the timer, you can press the **SNOOZE** button (23)/(37) to switch the unit off for approximately 9 minutes. After this time, the unit switches on again. You can press **SNOOZE** again, or switch the unit off by pressing **POWER**.

Setting the sleep timer:

When the unit is in operation it can be set to automatically switch-off 10 to 120 minutes later. Press **SLEEP** (25)/(52), as required, until the desired delay time appears on the display. The **SLEEP** timer can be set for: 120, 90, 60, 50, 40, 30, 20, and 10 minute intervals. The unit automatically turns off after the entered time has elapsed.

COMPACT DISC CHANGER

Safety notes for operation of the CD changer

Press one of the "OPEN / CLOSE" buttons (15) or (16) to open the right or left CD cover (2) or (26). The right and left CD cover do not opened or closed at the same time. Make sure the cover is not obstructed by any objects. This must also be ensured when closing the CD cover. The disc loader may only be opened or closed by pressing either the button "OPEN / CLOSE". Take care that no foreign objects can fall into the unit when the disc compartment is open.

Under no circumstance should the laser pick up lens be touched. Never look directly at the beam.

CD changer operation

Switch the unit on by pressing the "POWER" button (1)/(32). To turn on the CD mode, press the button "▶▶ PLAY / PAUSE" (13)/(38) or any one of the DISC 1-4 buttons (5) or (49). If one or more CD(s) have already been inserted in the chosen location(s), playback is started.

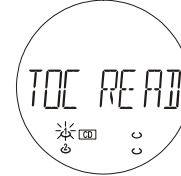

(TOC means Table of Contents) If there is no CD inside, the following will appear after a few seconds:



Inserting and ejecting the CD

The CD compartment (2)/(26) is opened for inserting or removing compact discs by pressing the "OPEN / CLOSE" (15) or (16) button.



Insert the disc with the unlabelled side facing the unit. Press the centre of the CD onto the black holder that is fitted with 3 retaining bearings. To remove the CD, hold it by the edges and lightly press on the holder to remove it.

Then close the disc compartment by pressing the "OPEN / CLOSE" button (15) or (16). After having closed the disc cover, the CD system immediately begins to scan the content of the compact disc. Subsequently, the number of tracks and the play-back time of the compact disc occupying position 1 appear in the display unit (3).



Playing the entire CD

Select the desired CD with the button "CD SELECTION 1 - 4" (5) or "DISC 1 - 4" (49) on the remote. Playback begins automatically.

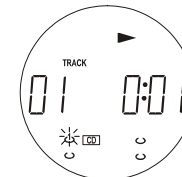

If the playback of one CD has finished, the playback of the next inserted CD begins, and so on.

Note: If the CD player is in stop position, you can start the currently indicated CD by pressing the button "▶▶ PLAY / PAUSE" (13)/(38). If you select a different CD by pressing the buttons "CD SELECTION 1 - 4" (5) or "DISC 1 - 4" (49), playback will start automatically.

Pause / stop

To briefly interrupt playback, press "▶▶ PLAY / PAUSE" button (13)/(38). The display indicates:



Press "▶▶ PLAY / PAUSE" button again to restart play. To end the playback, press the "■ STOP" button (11)/(45).

Random play

Press **RANDOM** on the remote control before or during CD play. The tracks in the CD will be played in random sequence.

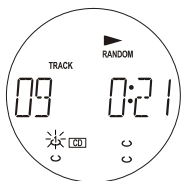

To cancel random play, press **STOP**, or press the **RANDOM** button again.

Repeat play

Press **REPEAT** once and the track being played will replay continuously.

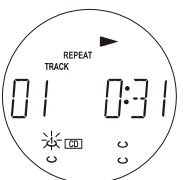

Press **REPEAT** twice to have the entire CD played continuously.

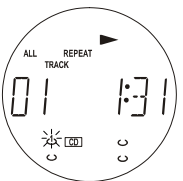

Press **REPEAT** three times to have all the inserted CDs (up to 4) played continuously.



Track selection

Press **TUNING + SKIP/SEARCH** and **TUNING - SKIP/SEARCH** to select the desired tracks. The tracks can be selected directly by pressing the corresponding numerical buttons **1 - 0 / +10**.

The selected number appears on the display. If the CD player is in stop mode, play starts automatically when a track is selected using the numerical buttons.

Search operation

While the CD is in play mode you can scan tracks by holding down **TUNING + SKIP/SEARCH** and **TUNING - SKIP/SEARCH**. The CD will continue to play until you find the track you want. When you release the button the unit will resume normal play mode.

Track intro-scan

Press **INTRO** while in stop mode to play the first 10 seconds of each track on all inserted CDs. Press **INTRO** again and the selected track plays.

Preset EQ function

Press the **EQ** button (6) or (39) repeatedly to cycle through the preset EQ shown on the LCD display - FLAT, POP, ROCK, JAZZ and DISCO.

Program memory

The built-in program memory lets you play up to 40 tracks (from up to 4 CDs) in the order of your choice. A track can be stored more than once within the program.

1. Load the CDs.
2. Press **MEM./CLK ADJ.** (9)/(50) in the stop mode to switch to programming mode.



3. Select a CD by pressing the corresponding **DISC 1 - 4** button.
4. Select the desired track using the numerical buttons **0 - 9 / +10** on the remote control or by repeatedly pressing **TUNING + SKIP/SEARCH** and **TUNING - SKIP/SEARCH**.



5. Press **MEM./CLK ADJ.** to save the track in the first program location. For example, if you selected CD 1, track number 14, it will appear in Program position 1 as shown.

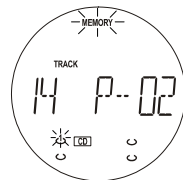

6. For the next program position, reselect this or another CD and select a track.
7. Confirm the selection using the **MEM./CLK ADJ.** button.
8. To program other tracks in the memory, repeat steps 3 - 7.

PLAYING MP3 DISCS

Inserting and ejecting an MP3 disc

The CD compartment (2)/(26) are opened for inserting or removing compact discs by pressing the **"OPEN / CLOSE"** (15)/(16) buttons.



Insert the MP3 disc with the unlabelled side facing the unit. Press the center of the CD onto the black holder fitted with 3 retaining bearings. To remove the CD, hold it by the edges and remove it by gently pressing on the black holder.

Then close the disc compartment by pressing the **"OPEN / CLOSE"** button (15) or (16). After having closed the disc cover, the CD system begins immediately to scan the content of compact disc inserted. Afterwards, the number of tracks and the play-back time of the compact disc occupying position 1 appear in the display unit (3).

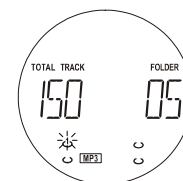

To play the program, press **PLAY/PAUSE**. The program can be played back again as long as **MEMORY** appears on the display.

To clear the programming and resume normal playback

The programming is erased by pressing **STOP** until the **MEMORY** display disappears, or by opening the CD changer door. If the unit is switched off, the program is not erased.

Note: **REPEAT** will not function in programmed play.

NOTE: This unit counts all the folders on an MP3 disc, even if a folder doesn't contain any MP3 file(s). If you select a folder which doesn't contain any MP3 file(s), the unit will automatically skip to the next folder until it finds one containing an MP3 file(s).

Playing the entire MP3 CD

1. Select the desired CD with the button **"CD SELECTION 1 - 4"** (5) or **"DISC 1 - 4"** (49) on the remote. Playback begins automatically.
2. To stop the disc playing, press the **"STOP"** button (11)/(45)

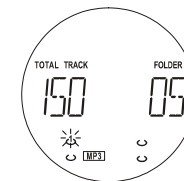

3. Press the **"FOLDER"** **▲** or **▼** button (24)/(19) or (46)/(44) to select desired MP3 album.

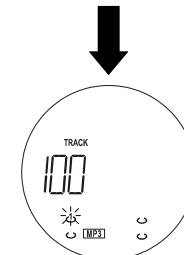
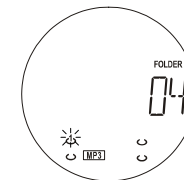

- Press the “**▶▶ TUNING +** or “**◀◀ TUNING -**” button (18) or (20) to select desired track.

- Press the “**PLAY/PAUSE**” button to play MP3.



Pause / stop

To briefly pause playback, press the “**▶|| PLAY / PAUSE**” button (13)/(38). Display indicates:



Press “**▶|| PLAY / PAUSE**” button again to restart play.

To end the playback, press the “**■ STOP**” button (11)/(45).

Playback in random sequence

Press the “**RANDOM**” button (35) on the remote control in stop condition to start random play.

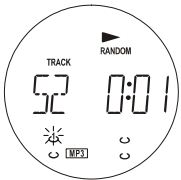

By pressing button “**■ STOP**” (11)/(45), the random playback is cancelled. This function can be switched off by pressing “**RANDOM**” button again.

Repeat

Press the “**REPEAT**” button (12)/(47) during MP3 playback to have the title currently being played at repeated continuously.

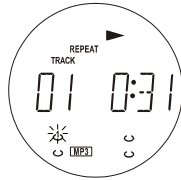

Press the “**REPEAT**” button again to have the entire MP3 disc played continuously.

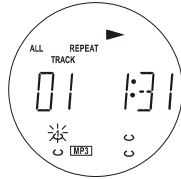

Press the “**REPEAT**” button again to have all the inserted MP3 discs played continuously.

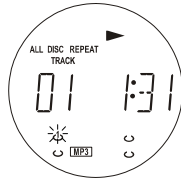

Title introduction

Press the “**INTRO**” button (34) during stop mode to playback the first 10 seconds of each title.

Press the “**INTRO**” push-button again and the CD player plays the current selected track.

Program memory

The built-in program memory enables up to 40 titles to be played from up to 4 CDs in the order of your choice. Any title can be stored more than once within one program.

- Insert a CD in its compartment.
- By pressing the button “**MEM./CLK ADJ.**” (9)/(50) in the stop mode you can switch to programming mode.

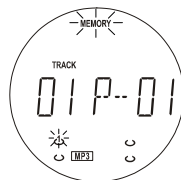

- Select the desired title using the numeric buttons “**0 - 9 / +10**” (33) on the remote control device or by repeatedly pressing “**▶▶ TUNING +** or **TUNING - ◀◀**”.

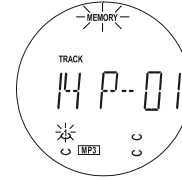

- Press the “**MEM./CLK ADJ.**” (9)/(50) to save the title on the first program location. In display unit (3) appears:

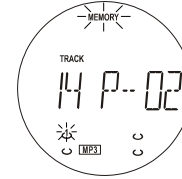

- Confirm selection using the “**MEM./CLK ADJ.**” button (9)/(50).
- To store the remaining titles in the memory, repeat steps 3 - 5.

To play back the program, press the “**▶|| PLAY / PAUSE**” button (13)/(38). When “**▶|| PLAY / PAUSE**” is pressed, the program can be played back again as long as **MEMORY** appears on the display unit (3).

To clear the programming (Resume Normal Playback):

The programming is erased by pressing the “**■ STOP**” button (11)/(45) in the programming mode (until the **MEMORY** display disappears), or by opening the disc compartment.

Note:

REPEAT button (12)/(47) is not used for programming.

ID3 TAG (Artist/Title)

When an MP3 disc is playing, press the “**MP3 MODE**” button repeatedly. The track no., title and artist information will be shown in the display if disc information is available.

To resume normal play display, press the “**MP3 MODE**” button repeatedly until playing time reappears.

CARE AND MAINTENANCE

- Treat the disc carefully. Handle the disc only by its edges. Never allow your fingers to contact with the shiny, unprinted side of the disc.
- Do not attach adhesive tape, stickers etc., to the disc label.
- Clean the disc periodically with soft, lint-free, dry cloth. Never use detergents or adhesive cleaners to clean the disc. If necessary, use a CD cleaning kit.
- If disc skips or gets stuck on a section of the disc, it is probably dirty or damaged (scratched).
- When cleaning the disc, wipe in straight lines from the centre of the disc to the edge of the disc. Never wipe in circular motions.
- To remove a disc from its storage case, press down on the centre of the case and lift the disc out, holding it carefully by the edges.
- Fingerprints and dust should be carefully wiped off the disc's recorded surface with a soft cloth. Unlike conventional records, compact disc have no groove to collect dust and microscopic debris, so gently wiping with a soft cloth should remove most particles.



SPECIFICATIONS

GENERAL

Power requirement -----	AC	120V ~ 60Hz
	DC	Battery size "CR2032" for Remote Handset
Power consumption -----	AC	35 Watts
Dimension -----	Unit	440 (W) x 171.5 (D) x 1075 (H)mm
	Speakers	207.7 (W) x 171.5 (D) x 1065 (H)mm

RECEIVER SECTION

Receiving bands -----	AM/FM
Tuning range -----	AM 530 - 1710KHz
	FM 87.5 - 108MHz

CD PLAYER SECTION

Playback system -----	4 CD front loading changer
Frequency response -----	60 - 18,000 Hz

AUDIO SECTION

Power output -----	12 Watts per channel
Speaker impedance -----	3 ohms
Headphone impedance -----	8 - 32 ohms

ACCESSORIES

Power AC cord	1 pc
Instruction Manual	1 set
Remote Control handset	1 pc